

Item No.	Specifications	Selection Chart	Performance Curve	Pump Dimensions	Sectional View
CDU70/1-3/4HP CDU70/3-1½HP CDU70/5-2HP CDU120/1-1HP CDU120/3-1½HP CDU120/5-3HP CDU200/1-½HP CDU200/3-3HP CDU200/5-3HP	301	302	303	310	311



**Note: NSF/ANSI 61 Annex G listed*

Certified to
NSF/ANSI 61, ANNEX G

**Model CDU
Specifications**

EBARA Stainless Steel Centrifugal Pumps

	Standard	Optional
Size Suction Discharge	CDU70 – 1¼" NPT thread CDU120 – 1¼" NPT thread CDU200 – 1½" NPT thread 1" NPT thread	
Range of HP	¾ HP to 3 HP	
Range of Performance Capacity Head	5.5 to 95 GPM at 3450 RPM 26 to 144 feet at 3450 RPM	
Liquid handled Type of liquid Temperature Max. working pressure	Water 212°F (100°C) 125 PSI (9 Bar)	Max. 250°F (121°C) with optional high temperature seal
Materials Casing Impeller (closed type) Shaft Bracket Shaft Seal Bearing	304L Stainless Steel 304L Stainless Steel Stainless Steel Aluminum Mechanical Seal – Type 21 Ball Bearing	High temperature version Mild chemical version
Direction of Rotation	Clockwise when viewed from motor end	
Motor Type Speed Single Phase Three Phase Motor Protection	NEMA 56J Frame 60 Hz, 3450 RPM (2 poles) TEFC – ¾ HP to 3 HP ODP – ¾ HP to 3 HP, 115/230V TEFC – ¾ HP to 3 HP ODP – ¾ HP to 3 HP, 208-230/460V Built-in overload protection (single phase)	Explosion proof – consult factory Washdown duty – consult factory

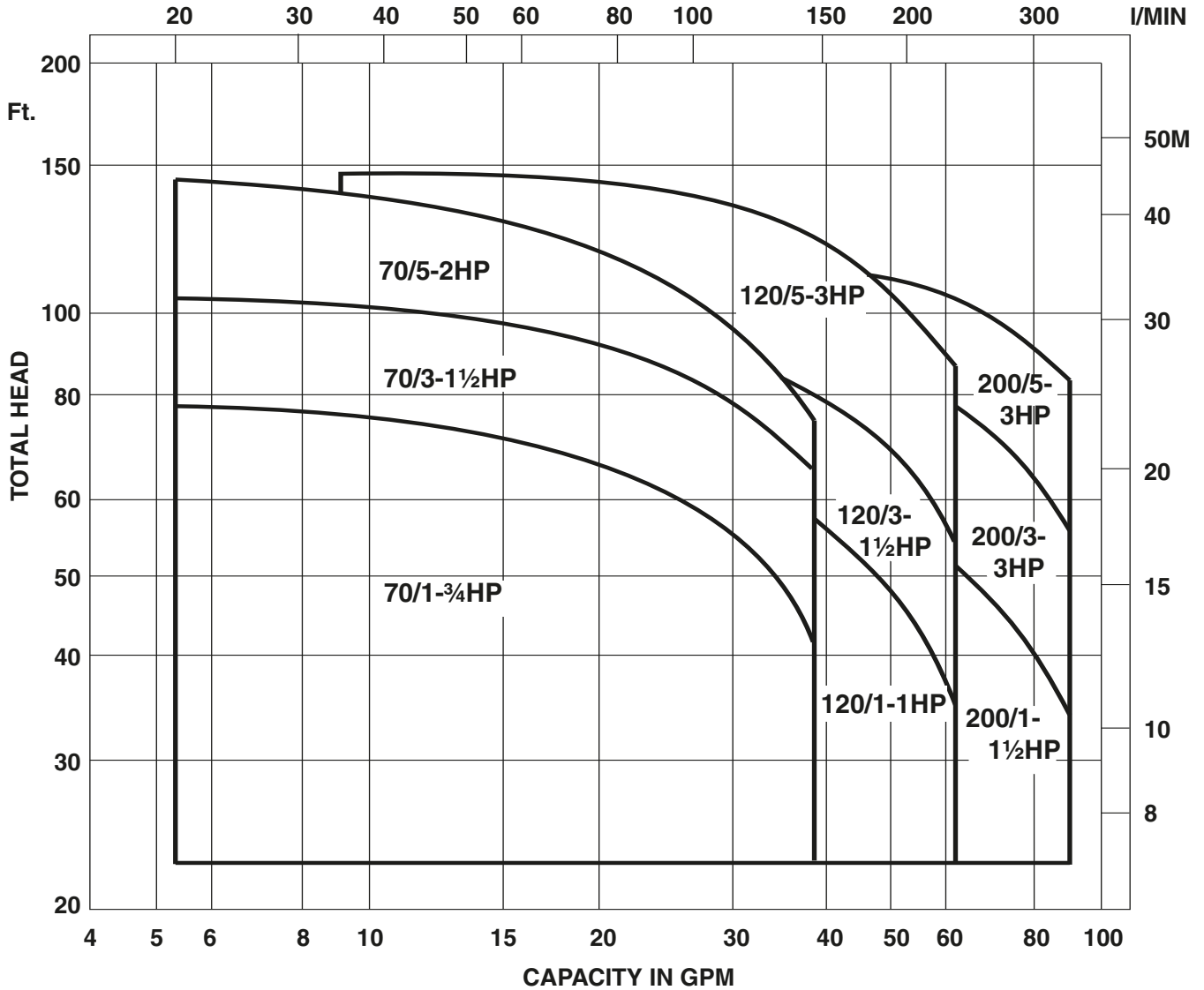

Model CDU

EBARA Stainless Steel Centrifugal Pumps

Performance Curves

CDU70/1-3/4 HP

Synchronous Speed: 3450 RPM

Size: 1 x 1 1/4 x 4 1/2

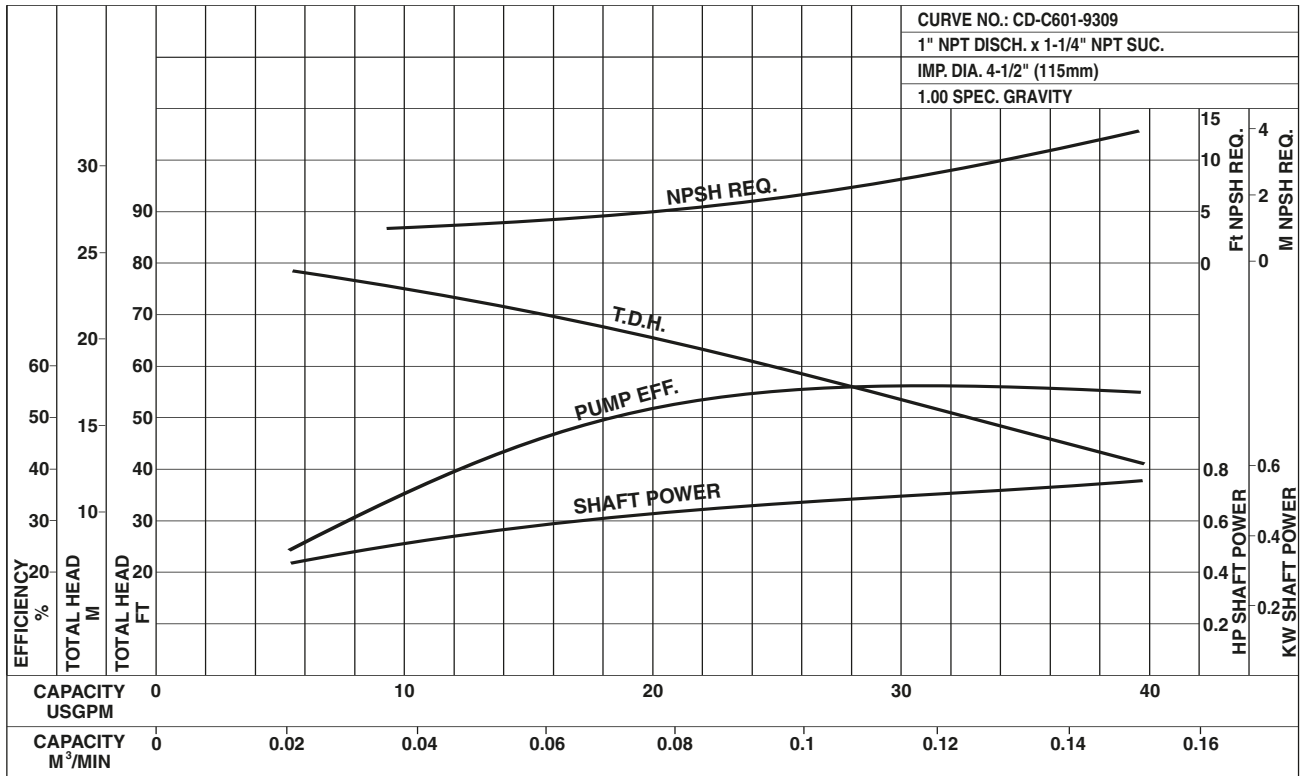

CDU70/3-1 1/2 HP

Synchronous Speed: 3450 RPM

Size: 1 x 1 1/4 x 5 3/16

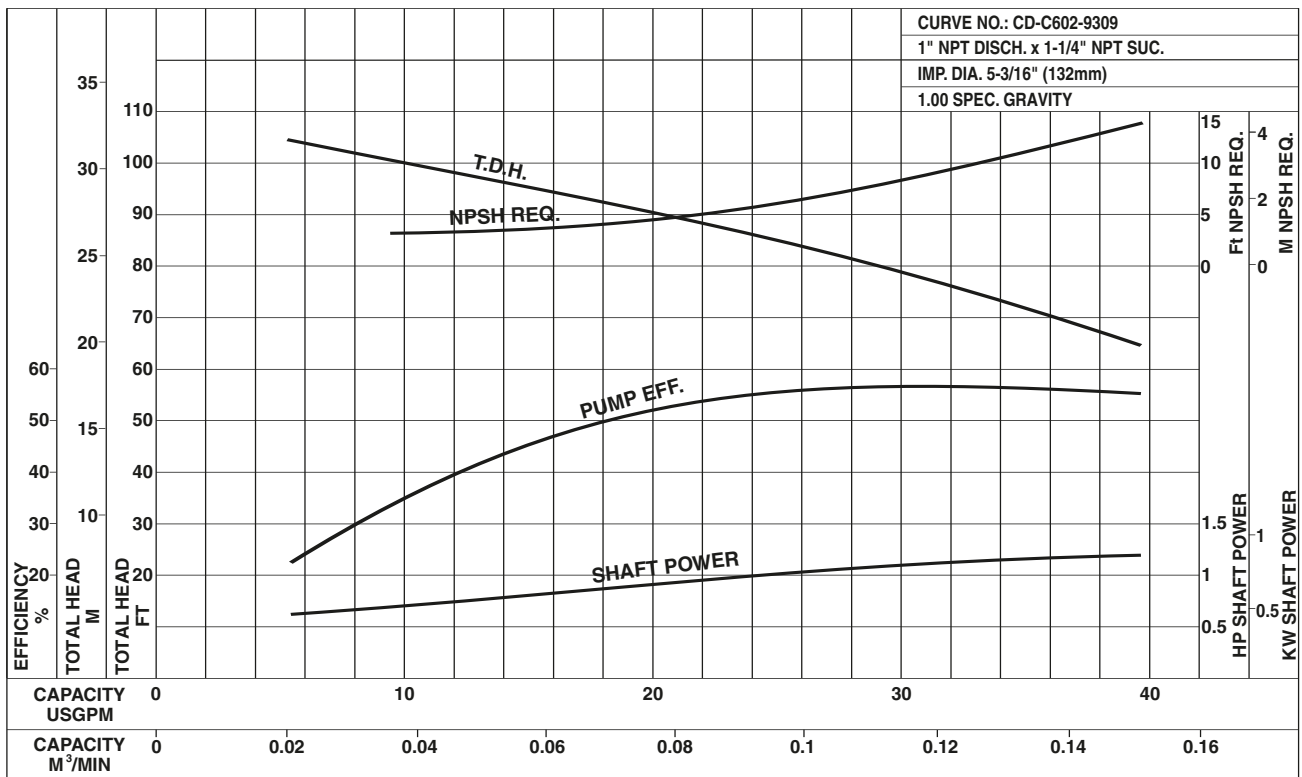

Model CDU

EBARA Stainless Steel Centrifugal Pumps

Performance Curves

CDU70/5-2HP

Synchronous Speed: 3450 RPM

Size: 1 x 1 1/4 x 6 3/16

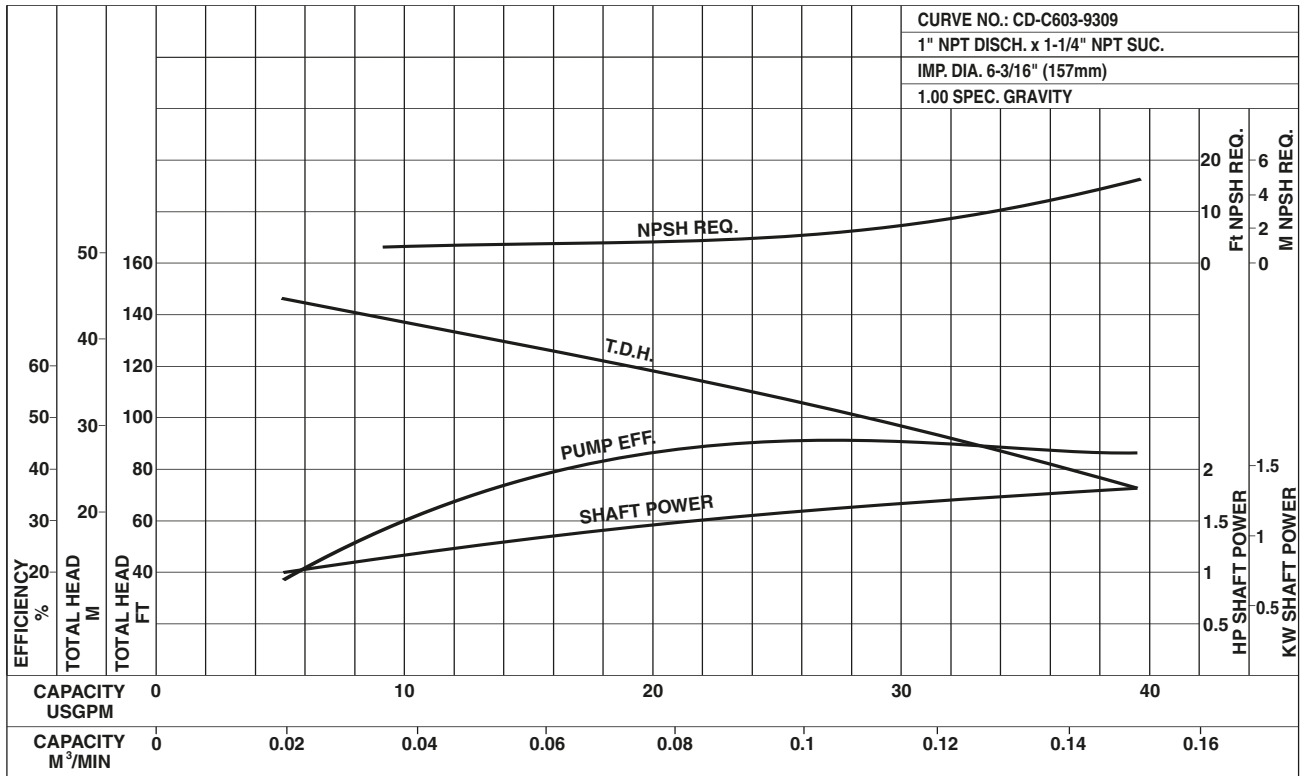

CDU120/1-1HP

Synchronous Speed: 3450 RPM

Size: 1 x 1 1/4 x 4 1/2

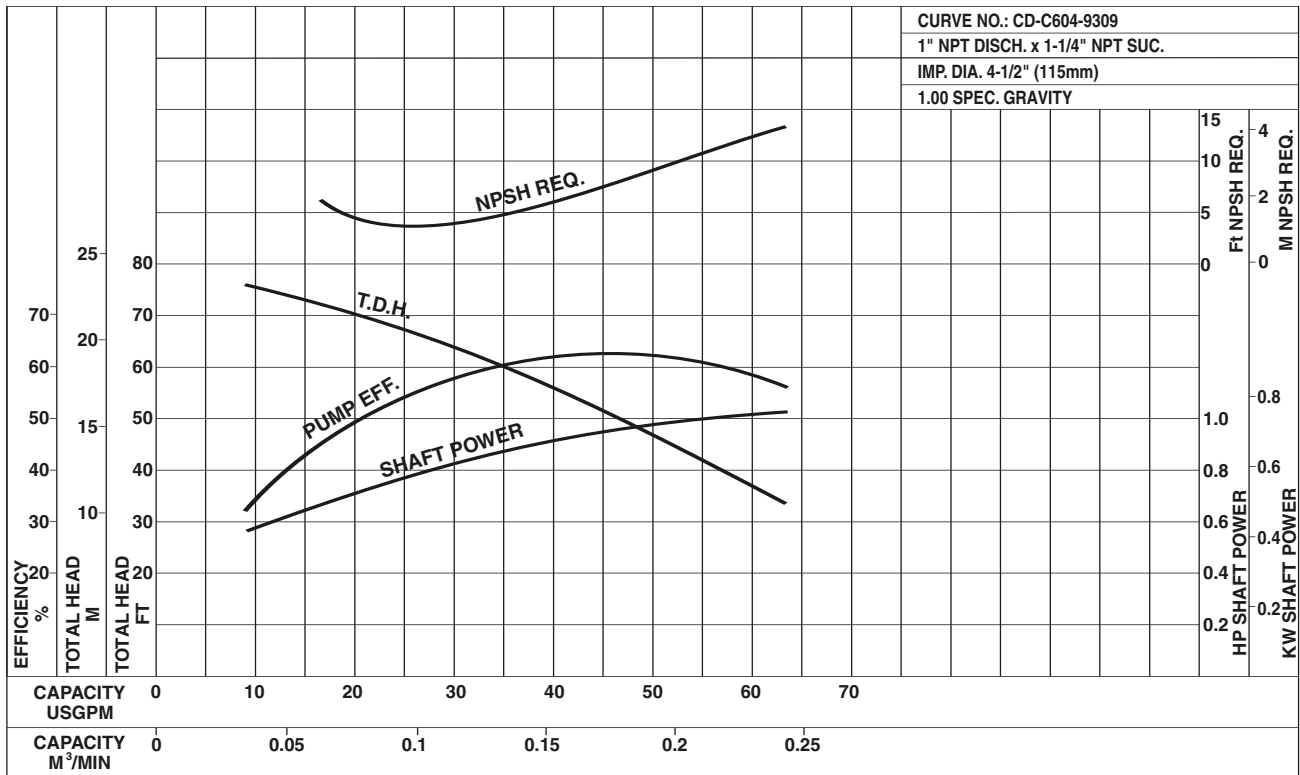

Model CDU
Performance Curves

EBARA Stainless Steel Centrifugal Pumps

CDU120/3-1 1/2 HP

Synchronous Speed: 3450 RPM

Size: 1 x 1 1/4 x 5 3/16

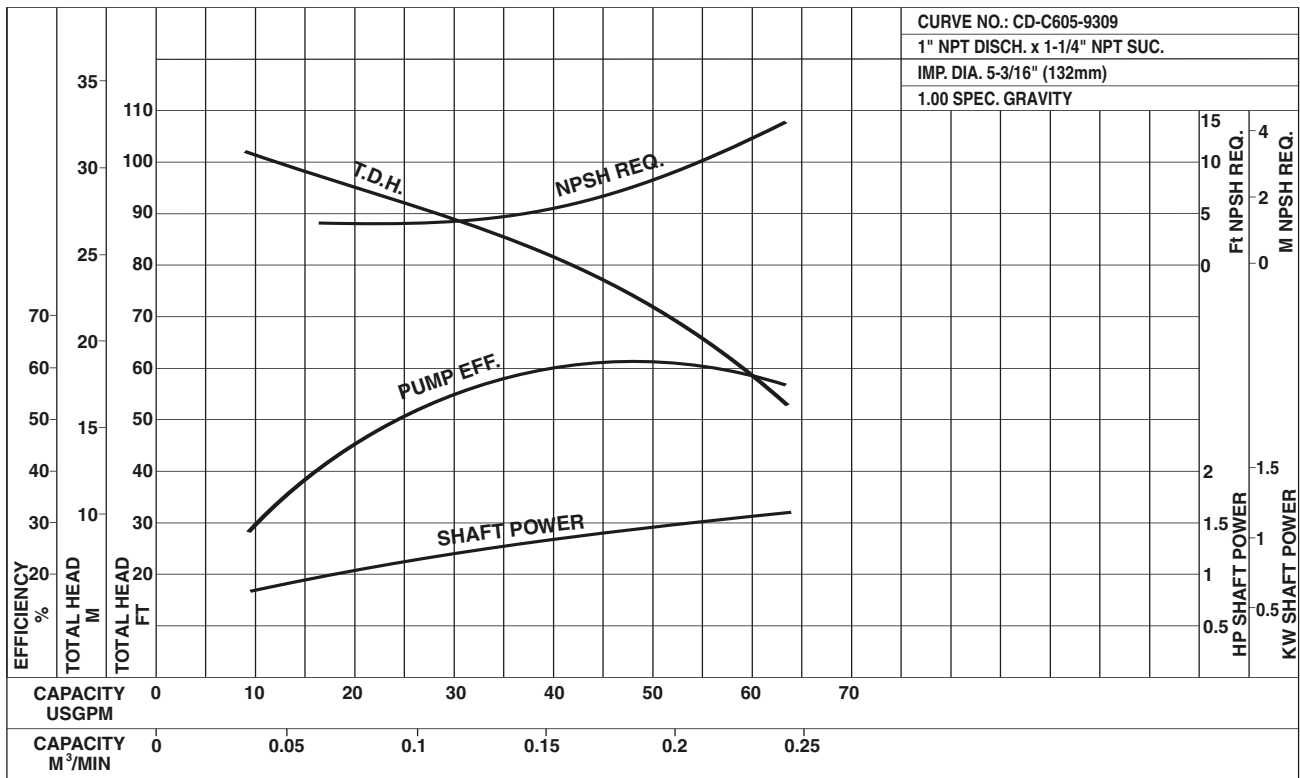

CDU120/5-3HP

Synchronous Speed: 3450 RPM

Size: 1 x 1 1/4 x 6 3/16

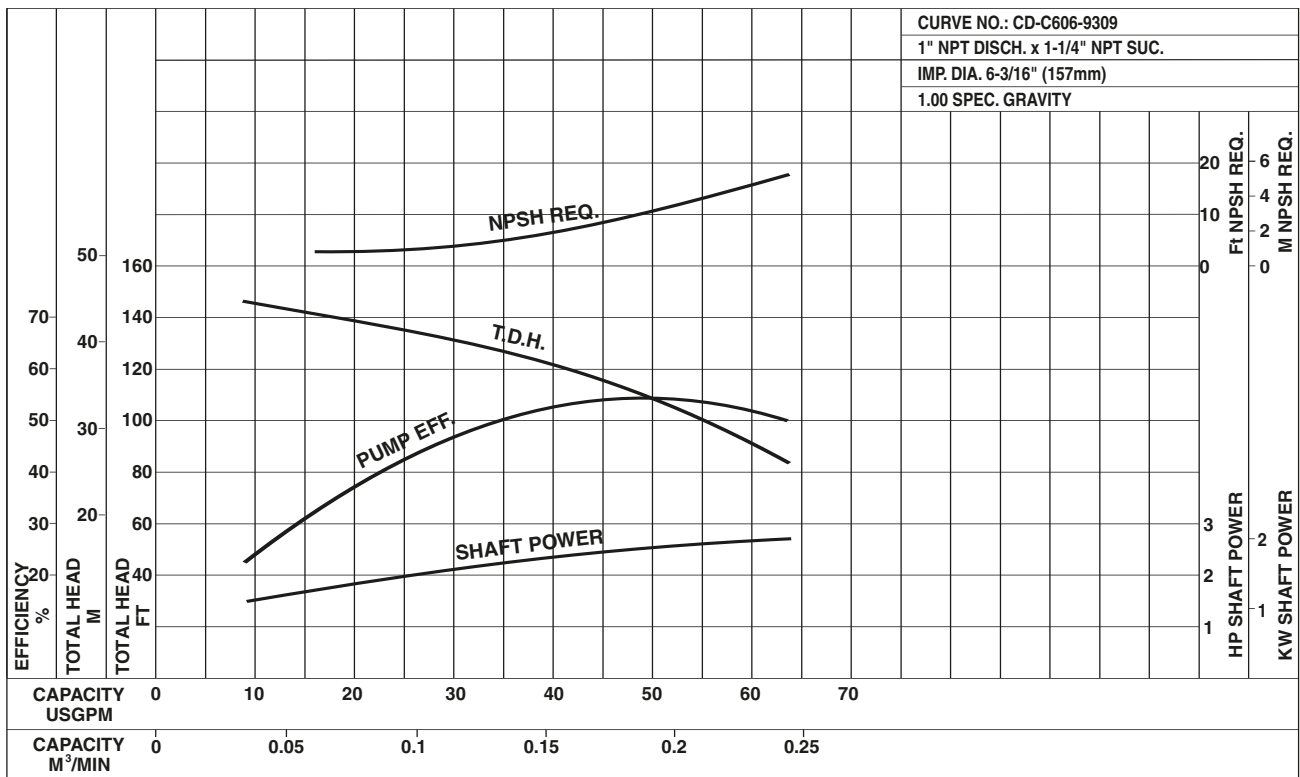

Model CDU

EBARA Stainless Steel Centrifugal Pumps

Performance Curves

CDU200/1-1½ HP

Synchronous Speed: 3450 RPM

Size: 1 x 1½ x 4½

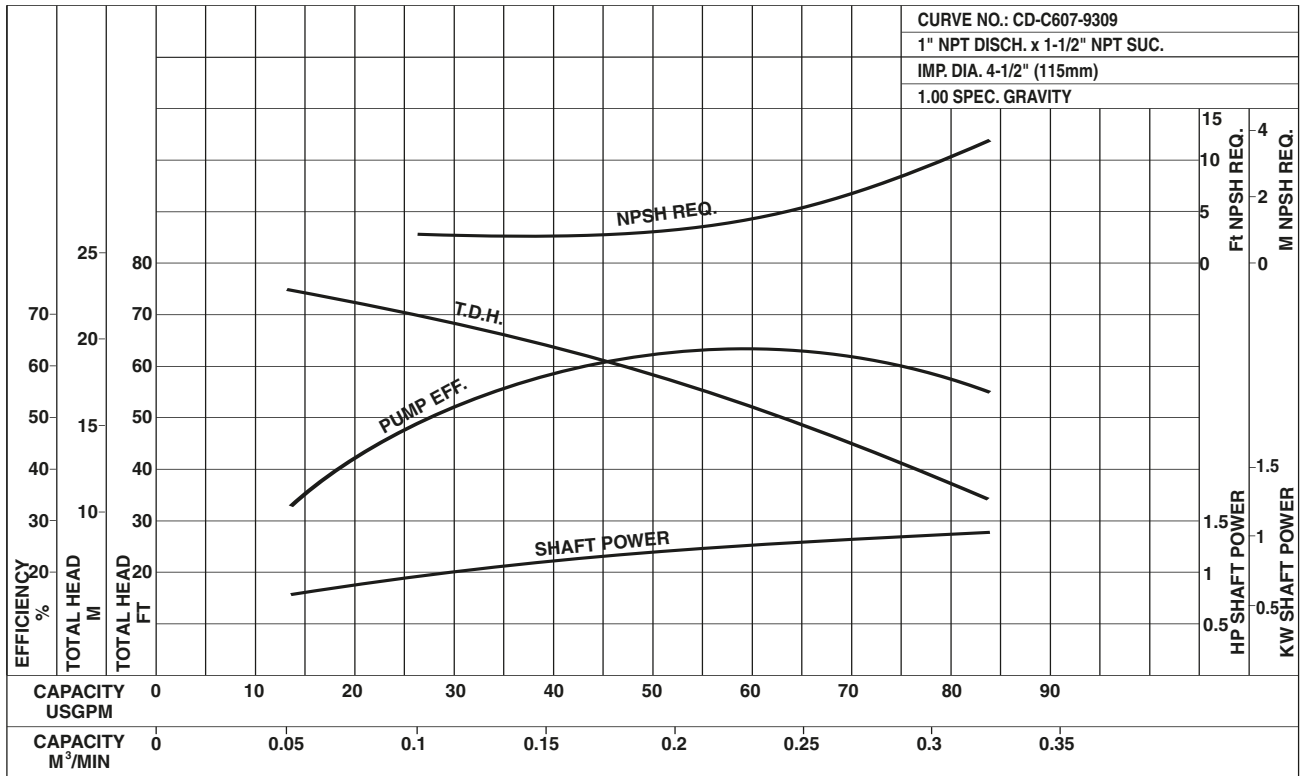

CDU200/3-3HP

Synchronous Speed: 3450 RPM

Size: 1 x 1½ x 5³/₁₆

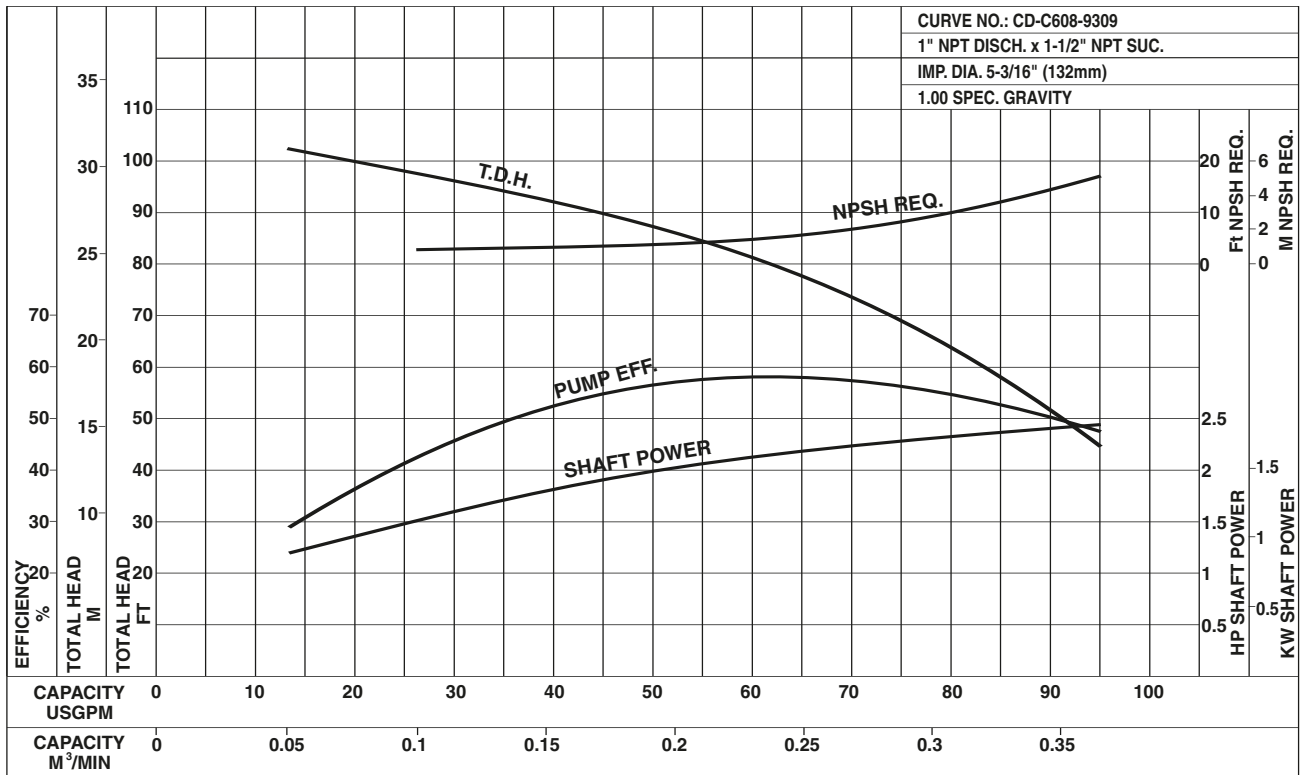

Model CDU
Performance Curves

EBARA Stainless Steel Centrifugal Pumps

CDU200/5-3HP

Synchronous Speed: 3450 RPM

Size: 1 x 1 1/2 x 5 11/16

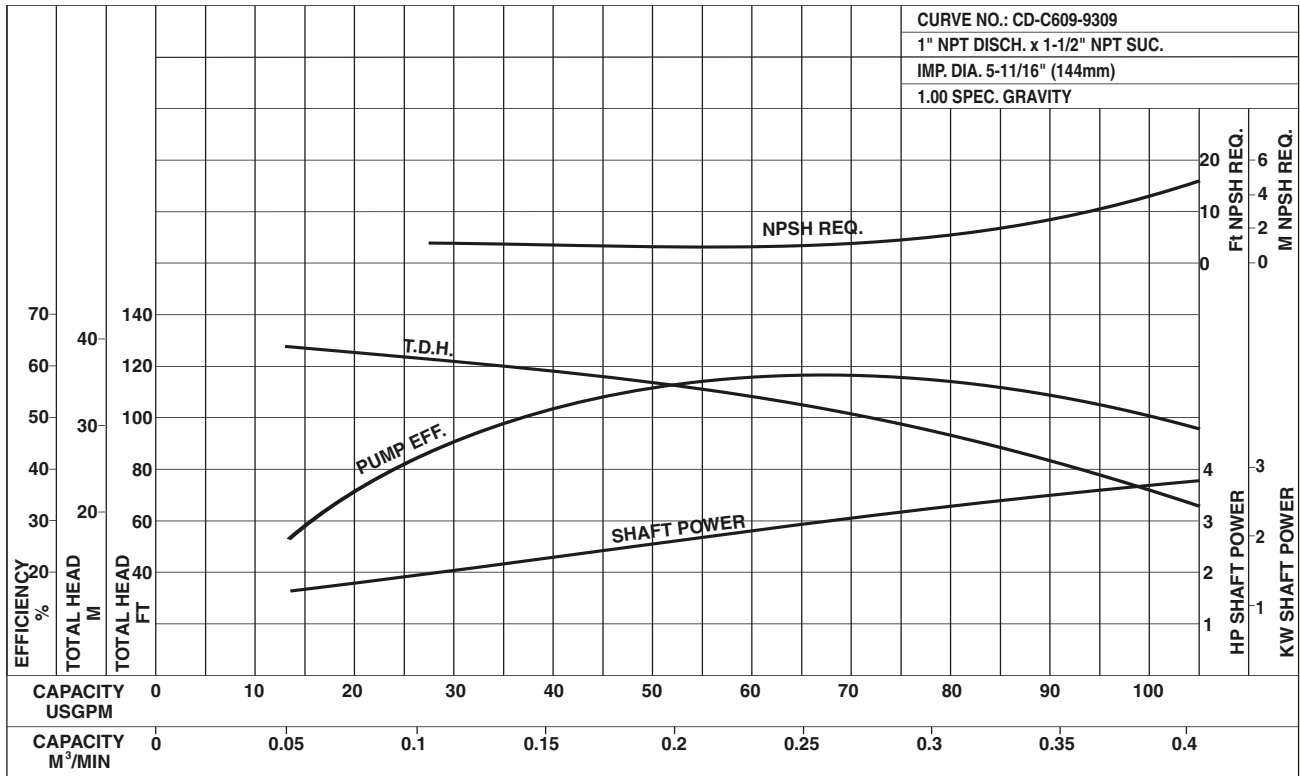

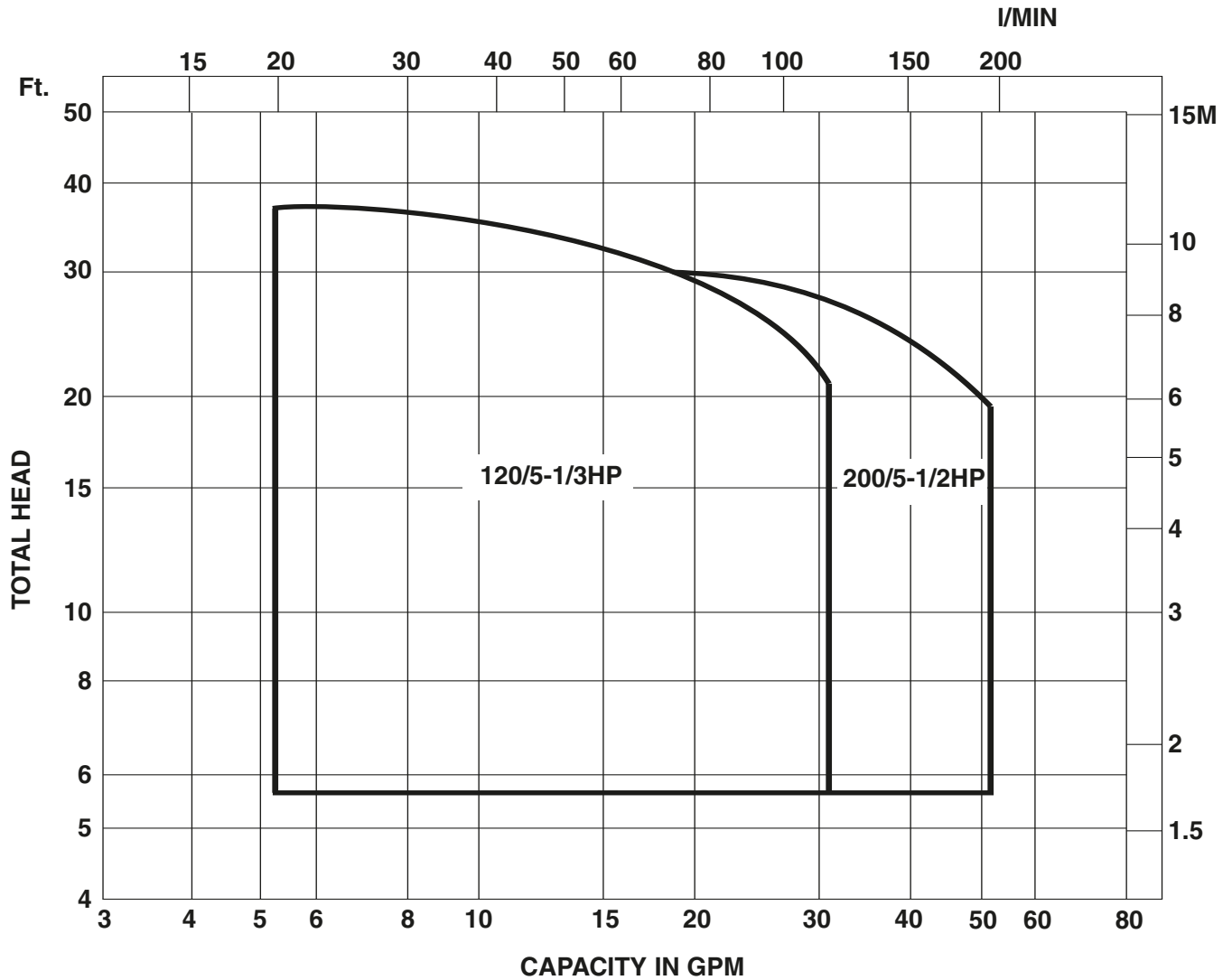

Model CDU
Performance Curves

EBARA Stainless Steel Centrifugal Pumps

CDU4 120/5-1/3 HP

Synchronous Speed: 1725 RPM

Size: 1 x 1 1/4 x 6³/16

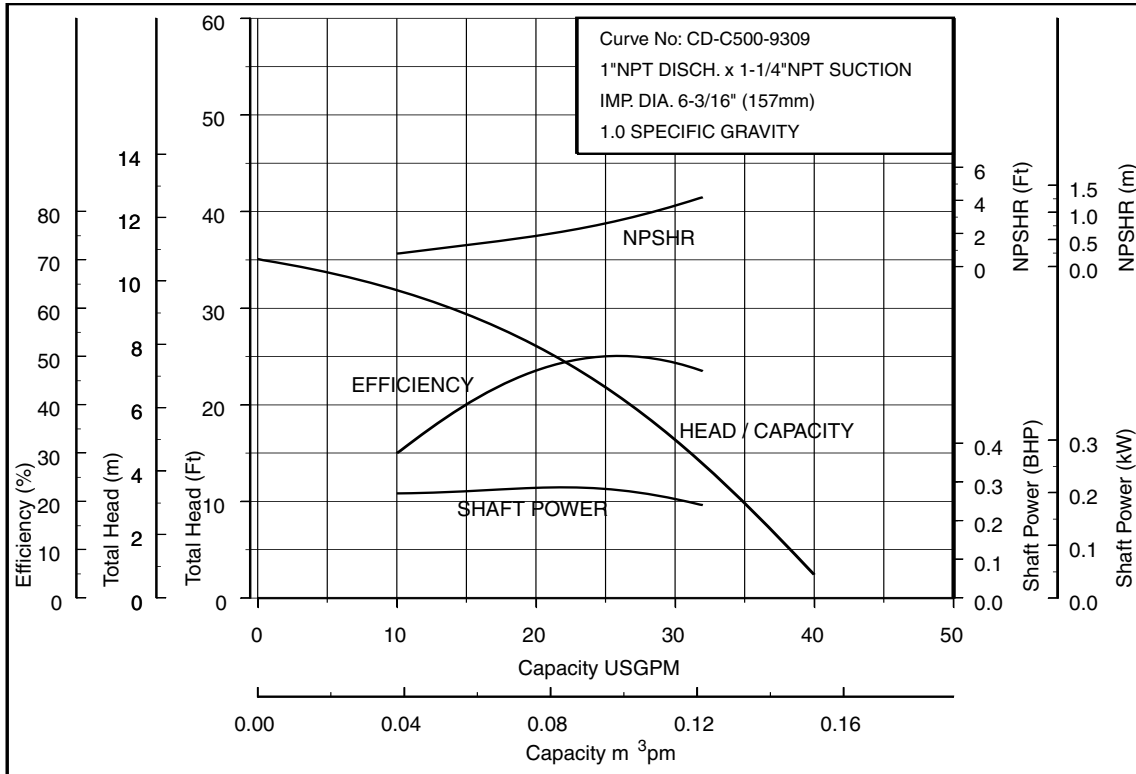

CDU4 200/5-1/2 HP

Synchronous Speed: 1725 RPM

Size: 1 x 1 1/2 x 5¹¹/16

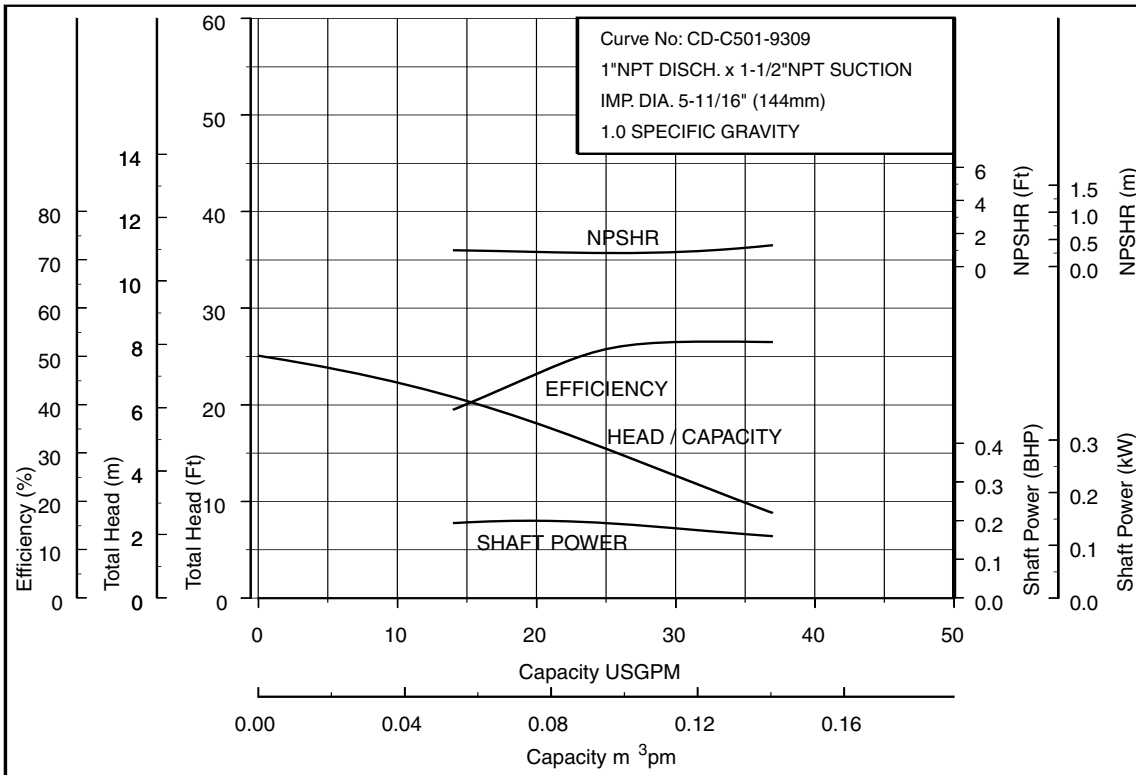

**Model CDU
Pump Dimensions**

EBARA Stainless Steel Centrifugal Pumps

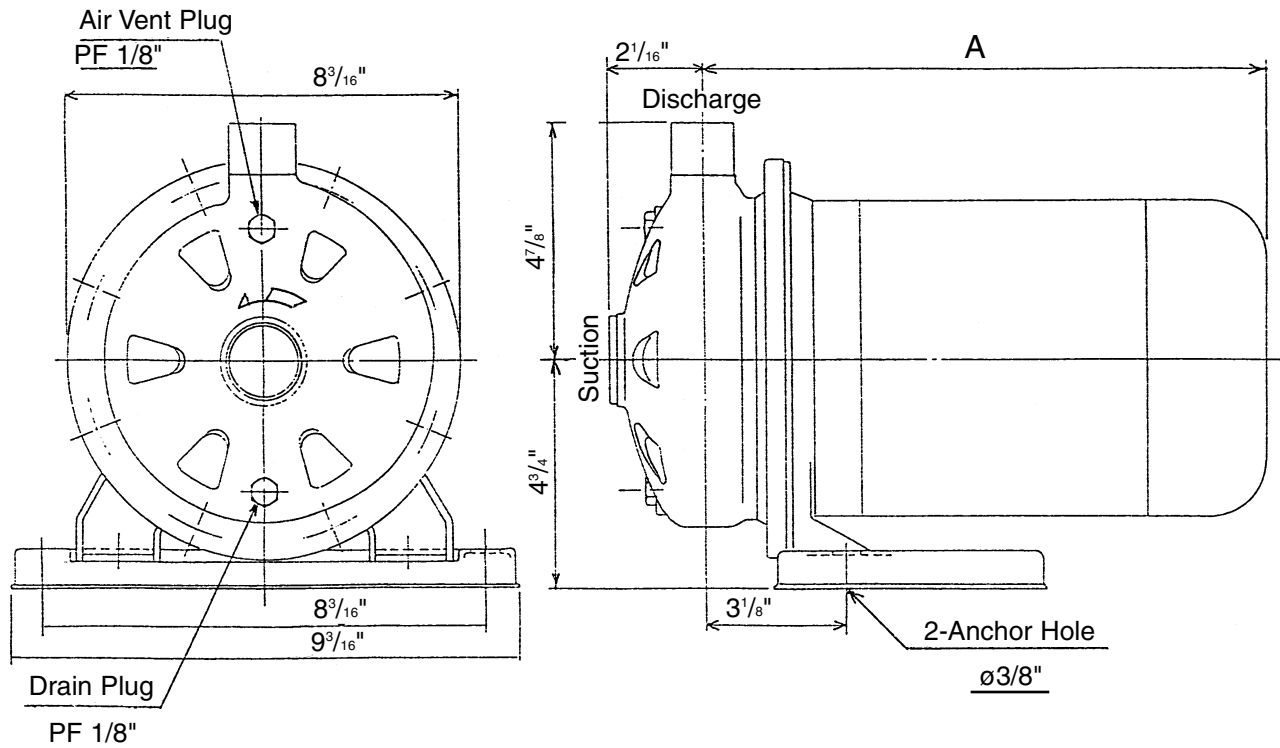

Model	Model	Pump Size – NPT (Inch)		Dimension (Inch)	Unit Weight (lbs.)			
		Suction	Discharge	A	Single Phase		Three Phase	
					ODP	TEFC	ODP	TEFC
CDU70/1-3/4HP	1 x 1 ¹ / ₄ x 4 ¹ / ₂	1 ¹ / ₄	1	13 ⁷ / ₈ Max.	36	41	31	31
CDU70/3-1 ¹ / ₂ HP	1 x 1 ¹ / ₄ x 5 ³ / ₁₆	1 ¹ / ₄	1	13 ⁹ / ₁₆ Max.	47	50	39	39
CDU70/5-2HP	1 x 1 ¹ / ₄ x 6 ³ / ₁₆	1 ¹ / ₄	1	14 ⁷ / ₁₆ Max.	51	58	44	48
CDU120/1-1HP	1 x 1 ¹ / ₄ x 4 ¹ / ₂	1 ¹ / ₄	1	13 ⁹ / ₁₆ Max.	41	46	33	32
CDU120/3-1 ¹ / ₂ HP	1 x 1 ¹ / ₄ x 5 ³ / ₁₆	1 ¹ / ₄	1	13 ⁹ / ₁₆ Max.	47	50	39	39
CDU120/5-3HP	1 x 1 ¹ / ₄ x 6 ³ / ₁₆	1 ¹ / ₄	1	14 ⁷ / ₁₆ Max.	59	66	51	60
CDU200/1-1 ¹ / ₂ HP	1 x 1 ¹ / ₂ x 4 ¹ / ₂	1 ¹ / ₂	1	13 ⁹ / ₁₆ Max.	47	50	39	39
CDU200/3-3HP	1 x 1 ¹ / ₂ x 5 ³ / ₁₆	1 ¹ / ₂	1	14 ⁷ / ₁₆ Max.	58	65	50	59
CDU200/5-3HP	1 x 1 ¹ / ₂ x 5 ¹¹ / ₁₆	1 ¹ / ₂	1	14 ⁷ / ₁₆ Max.	58	65	50	59



Model CDU
Sectional View

EBARA Stainless Steel Centrifugal Pumps

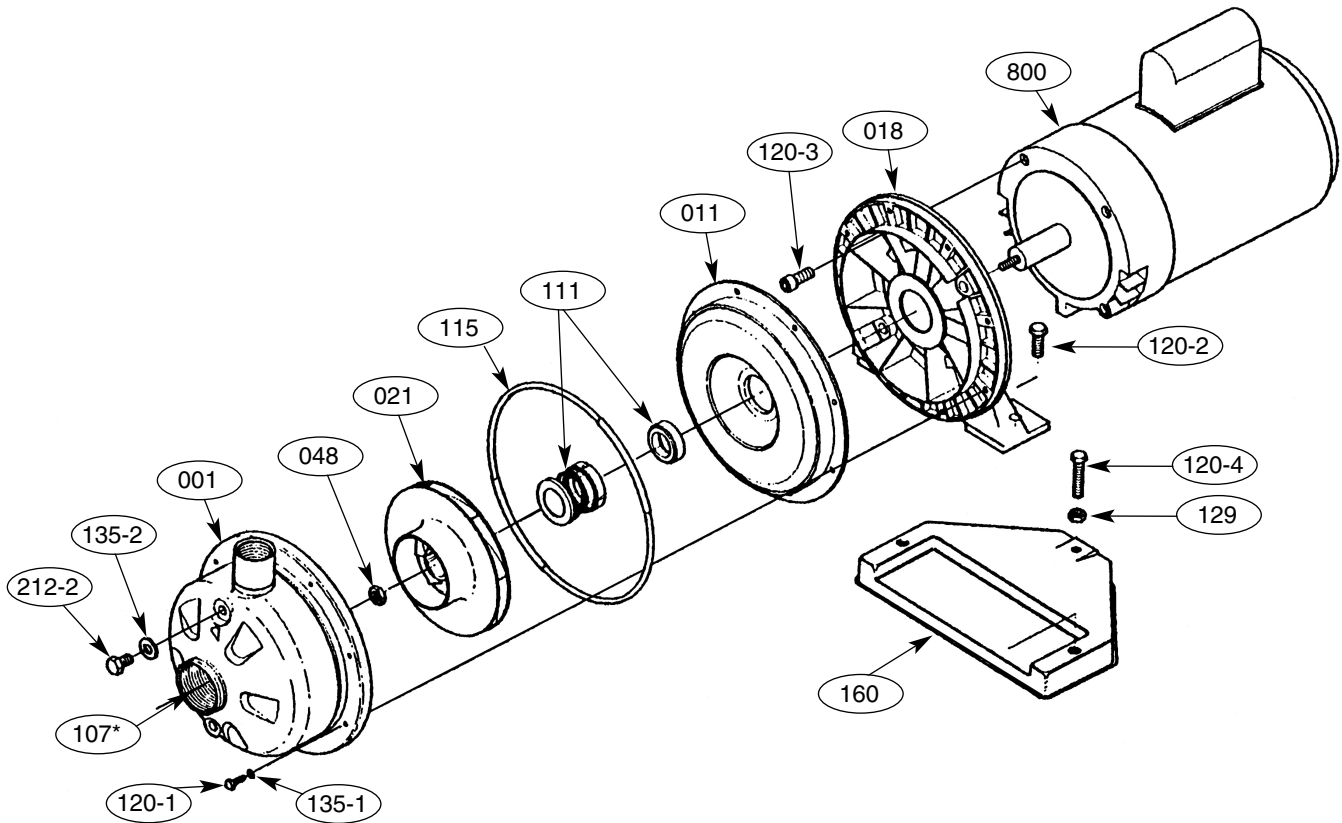

Part No.	Part Name	Material	No. for 1 Unit
001	Casing	304L Stainless	1
011	Casing cover	304L Stainless	1
018	Bracket	Aluminum	1
021	Impeller	304L Stainless	1
048	Impeller nut	304L Stainless	1
107*	Casing ring (*CDU 70 series only)	Viton	1
111	Mechanical seal	—	1
115	O-Ring	Viton	1
120-1	Bolt	304L Stainless	8
120-2	Bolt	304L Stainless	2
120-3	Bolt	304L Stainless	4
120-4	Bolt	304L Stainless	1
129	Nut	304L Stainless	1
135-1	Washer	304L Stainless	8
135-2	Washer	Aluminum	2
160	Base	Steel	1
212-2	Plug	304L Stainless	2
800	Motor	—	1